

PSALTIS
AUTO PARTS

ENEOS
JAPAN'S No.1 Oil Company

CYPRUS
AA

**CYPRUS RALLY
CHAMPIONSHIP**

ROAD BOOK



**FINIKOUDES
LARNACA RALLY 2025
02-04/05/2025**



ΜΕΓΑΣ ΥΠΟΣΤΗΡΙΚΤΗΣ



ΥΠΟΣΤΗΡΙΚΤΕΣ

- Sabelt**
- Di Capilla** *Sensible Stories*
- ΠΡΑΤΗΡΙΟ ΑΘΗΝΩΝ** *Κυριακός Π. Παυτός ΑΤΔ*
- klimacontrol** *HEATING & AIR CONDITIONING*
- METROPOLIS MALL**
- Hi-Tech PIAA**
- FlofosStylianou** (motors) ltd
- SMARTWAY MOTORS LTD** TEL: 20420967
- TOFALLI**
- ΚΟΑΛΑ ΠΕΤΡΕΛΑΙΑ ΛΤΔ**
-

Accident & Safety Procedure in a Special Stage

- 1)** All competitors must be conversant with Cyprus National Sporting Regulations 2024 Article 53 (Competitor Safety)
- 2)** If a crew is involved in an accident in which a member of the public sustains physical injury, the driver or co-driver concerned must remain at the scene and stop the following car, which must report this to the NEXT radiopoint as specified in the road book and signed on the route. The law of the country in which the rally is run must also be complied with in relation to procedures at accidents. All crews stopped by this procedure will be allocated a time according to the Cyprus National Sporting Regulations Article 39 (INTERRUPTION OF A SPECIAL STAGE).
- 3)** Any crew which has the red "SOS" sign displayed to them, or which sees a car which has suffered a major accident where both crew members are seen inside the car but are not displaying the red "SOS" sign, shall immediately and without exception stop to render assistance.
- 4)** All following cars shall also stop.
- 5)** The second car at the scene shall proceed to take to the next safety point the following information:
 - a.** Competition number for the crew involved.
 - b.** If and how many crew members or spectators are injured.
 - c.** If any crew member or spectator is trapped in or outside the car.
 - d.** Location of the accident, i.e. the closest road book junction or kilometre post.
 - e.** Any other vital information, e.g. fire, water.
- 6)** All competitors stopped in a stage must place their red triangle at least 50m before the car's position, even if the car is clear of the road.
- 7)** The event emergency telephone number is: **(+357) 99411134**
- 8)** If you wish to re-start from the start of the next Leg, you must confirm your intention to the clerk of the course one hour prior to the publication of the start list of the subsequent Leg.
- 9)** All competitors retiring from a Leg are obligated to hand in their time card to the sweeper car or any marshal at a time control or any Organisation Official as soon as possible.

Διαδικασία Ατυχημάτων & Ασφάλειας στις Ειδικές Διαδρομές

- 1) Όλοι οι συμμετέχοντες πρέπει να γνωρίζουν το άρθρο 53 (Ασφάλεια διαγωνιζόμενου) των Εθνικών Κανονισμών Αγώνων Ράλλυ 2024.
- 2) Αν ένα πλήρωμα εμπλακεί σε ατύχημα στο οποίο τραυματίστηκε θεατής, ο εμπλεκόμενος οδηγός ή ο συνοδηγός πρέπει να παραμείνει στη σκηνή και να σταματήσει το αυτοκίνητο που ακολουθεί, το οποίο πρέπει να το αναφέρει στον επόμενο ενδιάμεσο ασυρματιστή που αναφέρεται στο βιβλίο διαδρομής. Οι νόμοι της χώρας στην οποία διεξάγεται ο αγώνας πρέπει επίσης να τηρούνται σε σχέση με τις διαδικασίες σε περίπτωση ατυχήματος. Όλα τα αυτοκίνητα που έχουν σταματήσει από αυτή τη διαδικασία θα τους δοθεί χρόνος, σύμφωνα με τον Εθνικό Κανονισμό Αγώνων Ράλλυ άρθρο 39 (ΔΙΑΚΟΠΗ ΤΗΣ ΕΙΔΙΚΗΣ ΔΙΑΔΡΟΜΗΣ).
- 3) Σε κάθε πλήρωμα που επιδεικνύεται το κόκκινο σήμα "SOS", ή δει ένα αυτοκίνητο να έχει υποστεί σοβαρό ατύχημα του οποίου τα δύο μέλη του πληρώματος βρίσκονται μέσα στο αυτοκίνητο, αλλά δεν επιδεικνύουν το κόκκινο σήμα "SOS", ενημερώνει αμέσως και χωρίς εξαίρεση οφείλει να σταματήσει για παροχή βοήθειας.
- 4) Όλα τα αυτοκίνητα που ακολουθούν θα σταματήσουν επίσης.
- 5) Το δεύτερο αυτοκίνητο στο σημείο του ατυχήματος θα προχωρήσει στον επόμενο σημείο safety για να δώσει τις ακόλουθες πληροφορίες:
 - α. Αριθμός Διαγωνιζόμενου που εμπλέκεται στο δυστύχημα.
 - β. Αν και πόσα μέλη του πληρώματος ή θεατές τραυματίστηκαν.
 - γ. Εάν κάποιο μέλος του πληρώματος ή θεατής παγιδεύτηκε μέσα ή έξω από το αυτοκίνητο.
 - δ. Τοποθεσία του ατυχήματος, δηλαδή την πλησιέστερη τουλίπα του βιβλίου διαδρομής.
 - ε. Οποιαδήποτε άλλη σημαντική πληροφορία, π.χ. φωτιά, νερό.
- 6) Όλοι οι διαγωνιζόμενοι που σταματούν στην ειδική διαδρομή πρέπει να τοποθετούν το κόκκινο τρίγωνο τους τουλάχιστον 50 πριν από την θέση του αυτοκινήτου, ακόμη και αν το αυτοκίνητο είναι έξω από το δρόμο.
- 7) Ο αριθμός κλήσης έκτακτης ανάγκης είναι: **(+357) 99411134**
- 8) Εάν θέλετε να ξαναρχίσετε από την αρχή του επόμενου σκέλους, θα πρέπει να επιβεβαιώσετε την πρόθεσή σας στον αλυτάρχη μια ώρα πριν από τη δημοσίευση της λίστας εκκίνησης του επόμενου σκέλους.
- 9) Όλοι οι διαγωνιζόμενοι που εγκαταλείπουν από ένα σκέλος είναι υποχρεωμένοι να παραδώσουν τη κάρτα χρόνου στο ουραγό αυτοκίνητο ή οποιοδήποτε κριτή σε ένα σταθμό ελέγχου χρόνου ή σε οποιοδήποτε μέλος της Οργανωσης το συντομότερο δυνατό

Nearest Hospital per stage

SS1 / SS3	YERI	NICOSIA GENERAL HOSPITAL	22 603000
SS2 / SS4	PETROFANI	LARNACA GENERAL HOSPITAL	24 800500
SS5	ATHIENOU	LARNACA GENERAL HOSPITAL	24 800500
SS6 / 7 / 8	KOTSIATIS	NICOSIA GENERAL HOSPITAL	22 603000

Symbols

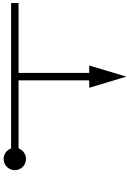

Direction to follow



Village entrance
Speed limit 50km/h

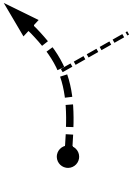

Gravel road



Motorway



Direction to follow



Leave motorway



Do not change
direction



Refueling area



Over bridge



Building



Electricity post



Traffic lights

Ceremonial Start							Friday 2 May 2025
SS / TC	Location	SS dist.	Liaison distance	Total distance	Target time	First car due	
CS	Ceremonial Start - Finikoudes					20:30	

Cerem. Start

Sunrise: 05:38 Sunset: 19:51

LEG 1, Sections 1 - 2 - 3							Saturday 3 May 2025
SS / TC	Location	SS dist.	Liaison distance	Total distance	Target time	First car due	
0	Service Park Out (GSZ Stadium)					10:30	
RZ	Refueling Zone (GSZ Stadium)						
1	Distance to next refuel	23.20	76.57	99.77			
1			39.00	39.00	00:50	11:20	
SS1	Smartway Motors Yeri 1	10.02				11:23	
2			23.06	33.08	01:00	12:23	
SS2	Klimacontrol Petrofani 1	13.18				12:26	
2A	Regrouping IN & Technical Zone IN		14.51	27.69	00:35	13:01	
	Regrouping (Larnaca)				00:15		
2B	Regrouping OUT, Service IN					13:16	
	Service A (Larnaca)	23.20	76.57	99.77	00:30		
2C	Service OUT					13:46	
RZ	Refueling Zone (GSZ Stadium)						
2	Distance to next refuel	23.20	76.57	99.77			
3			39.00	39.00	00:50	14:36	
SS3	Smartway Motors Yeri 2	10.02				14:39	
4			23.06	33.08	01:00	15:39	
SS4	Klimacontrol Petrofani 2	13.18				15:42	
4A	Regrouping IN & Technical Zone IN		14.51	27.69	00:35	16:17	
	Regrouping (Larnaca)				00:15		
4B	Regrouping OUT, Service IN					16:32	
	Service B (Larnaca)	23.20	76.57	99.77	00:30		
4C	Service OUT					17:02	
RZ	Refueling Zone (GSZ Stadium)						
3	Distance to next refuel	2.07	29.87	31.94			
5			14.39	14.39	00:25	17:27	
SS5	Psaltis - ENEOS Super Special Stage Athienou	2.07				17:30	
5A	Technical Zone IN		15.48	17.55	00:35	18:05	
5B	Technical Zone Out, Service IN				00:03	18:08	
	Service C (Larnaca)	2.07	29.87	31.94	00:45		
5C	Service OUT / Park Ferme In (Early Arrival Allowed)					18:53	

Section 1

Section 2

Section 3

Leg 1 totals	48.47	183.01	231.48
---------------------	--------------	---------------	---------------

Sunrise: 05:38 Sunset: 19:52

LEG 2, Sections 4 - 5

Sunday 4 May 2025







SS / TC	Location	SS dist.	Liaison distance	Total distance	Target time	First car due
5D	Parc Fermé OUT - SERVICE IN					09:30
Service D (Larnaca)		0.00	0.00	0.00	00:15	
5E	Service OUT					09:45
RZ 4	Refueling Zone (GSZ Stadium) Distance to next refuel	27.28	76.68	103.96		
6			31.56	31.56	00:50	10:35
SS6	APK Capac Auto Parts Kotsiatis 1	13.64				10:38
6A	Holding control IN		5.65	19.29	00:30	11:08
	Holding control				00:50	
6B	Holding control OUT					11:58
7			2.15	2.15	00:10	12:08
SS7	APK Capac Auto Parts Kotsiatis 2	13.64				12:11
7A	Regrouping IN & Technical Zone IN		37.32	50.96	01:00	13:11
	Regrouping (Larnaca)				00:15	
7B	Regrouping OUT, Service IN					13:26
Service E (Larnaca)		27.28	76.68	103.96	00:30	
7C	Service OUT					13:56
RZ 5	Refueling Zone (GSZ Stadium) Distance to next refuel	13.64	68.88	82.52		
8			31.56	31.56	00:50	14:46
SS8	APK Capac Auto Parts Kotsiatis 3	13.64				14:49
8A	Technical Zone IN		37.32	50.96	01:00	15:49
8B	Technical Zone OUT, Service IN				00:03	15:52
Service F (Larnaca)		13.64	68.88	82.52	00:15	
8C	Service OUT					16:07
RZ 6	Refueling Zone (GSZ Stadium) Distance to next refuel	0.00	4.44	4.44		
8D	Holding control - Finish (Finikoudes - Early Arrival Allowed)		4.44	4.44	00:30	16:37
	Podium (Finikoudes)					18:00





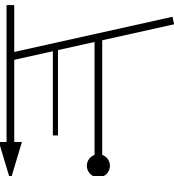

Leg 2 totals

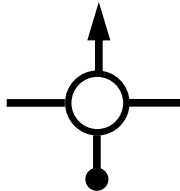
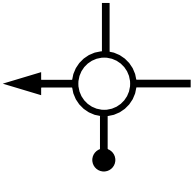
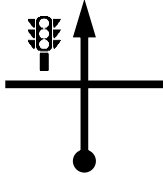
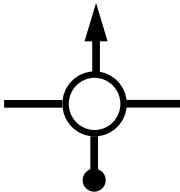
40.92 150.00

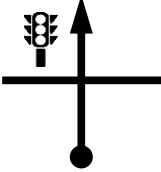
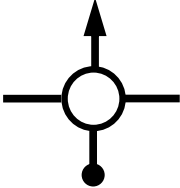
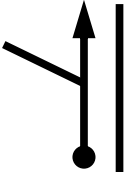
RALLY TOTALS

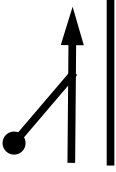
Leg	No. of SS	SS distance	Liaison distance	Total distance
Saturday 03 May 2025 - Sections 1,2,3	5	48.47	183.01	231.48
Sunday 04 May 2025 - Sections 4,5	3	40.92	150.00	190.92
Overall Totals	8	89.39	333.01	422.40

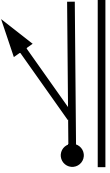
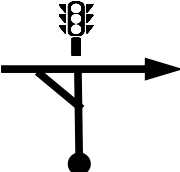
TC0/2C SERVICE OUT		DISTANCE:		LEG: 1		
TC1/3 YERI		39.00 km		SECTION: 1/2		
		AVERAGE 46.80 km/h		TIME ALLOWED: 50 min		
DISTANCE		DIRECTION		INFORMATION		DISTANCE REGRESS.
TOTAL	PARTIAL					
0.00	0.00	1		 TC 0/2C SERVICE OUT <div style="border: 1px solid black; padding: 2px; width: fit-content; margin: 5px auto;">N34 55.004 E33 38.288</div>	39.00	
0.07	0.07	2		  	38.93	
0.33	0.26	3		MALL	38.67	
0.65	0.32	4		Take the 1st exit	38.35	
1.50	0.85	5			37.50	
2.23	0.73	6		Take the 2nd exit	36.77	

TC0/2C SERVICE OUT		DISTANCE:		LEG: 1	
TC1/3 YERI		39.00 km		SECTION: 1/2	
		AVERAGE		TIME ALLOWED:	
		46.80 km/h		50 min	
DISTANCE		DIRECTION	INFORMATION	DISTANCE REGRESS.	
TOTAL	PARTIAL				
3.15	0.92	7 			35.85
4.56	1.41	8 	Take the 2nd exit Join motorway (Rizoelia)		34.44
9.90	5.34	9 			29.10
23.77	13.87	10 	JOIN MOTORWAY LIMASSOL - NICOSIA 		15.23
28.00	4.23	11 	EXIT MOTORWAY		11.00
28.49	0.49	12 			10.51

TC0/2C SERVICE OUT		DISTANCE:	LEG:	1
TC1/3 YERI		39.00 km	SECTION:	1/2
		AVERAGE	TIME ALLOWED:	
		46.80 km/h		50 min
DISTANCE		DIRECTION	INFORMATION	DISTANCE REGRESS.
TOTAL	PARTIAL			
28.71	0.22	<div style="text-align: center;"> </div>		10.29
		13		
29.24	0.53	<div style="text-align: center;"> </div>	KYRIS MOTORS	9.76
		14		
31.77	2.53	<div style="text-align: center;"> </div>	AYIOS ARTEMIOS CHURCH 	7.23
		15		
33.37	1.60	<div style="text-align: center;"> </div>		5.63
		16		
37.70	4.33	<div style="text-align: center;"> </div>		1.30
		17		
37.80	0.10	<div style="text-align: center;"> </div>		1.20
		18		

TC0/2C SERVICE OUT		DISTANCE:	LEG:	1
TC1/3 YERI		39.00 km	SECTION:	1/2
		AVERAGE	TIME ALLOWED:	50 min
		46.80 km/h		
DISTANCE		DIRECTION	INFORMATION	DISTANCE REGRESS.
TOTAL	PARTIAL			
38.03	0.23	 19		0.97
38.70	0.67	 20		0.30
39.00	0.30	CEMETARY 21	TC 1/3 YERI <div style="border: 1px solid black; padding: 2px; display: inline-block;"> N34 51.392 E33 23.212 </div>	0.00

TC 1/3	YERI	DISTANCE:	LEG: 1
TC 2/4	PETROFANI	33.08 km	SECTION: 1/2
SPECIAL STAGE	1/3	AVERAGE	TIME ALLOWED:
Yeri	9.82 km	33.08 km/h	60min



TC 1/3	YERI	DISTANCE:	LEG:	1
TC 2/4	PETROFANI	33.08 km	SECTION:	1/2
SPECIAL STAGE		1/3	AVERAGE	TIME ALLOWED:
Yeri		9.82 km	33.08 km/h	60min







TC 1/3		YERI		DISTANCE:		LEG: 1	
TC 2/4		PETROFANI		33.08 km		SECTION: 1/2	
SPECIAL STAGE				1/3		AVERAGE	
Yeri				9.82 km		33.08 km/h	
						TIME ALLOWED: 60min	
DISTANCE		DIRECTION		INFORMATION		DISTANCE REGRESS.	
TOTAL	PARTIAL						
0.00	0.00	1		 START SS1/3 YERI 1 <div style="border: 1px solid black; padding: 2px; display: inline-block;">N35 06.532 E33 26.120</div>	33.08		
0.08	0.08	2			33.00		
0.16	0.08	3			32.92		
0.31	0.15	4		Keep Right	32.77		
1.33	1.02	5		!!! CAUTION !!! !!! JUMP !!!	31.75		
1.64	0.31	6			31.44		

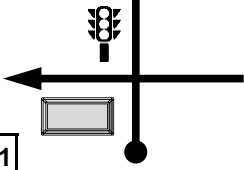
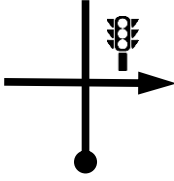
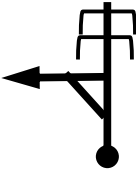

TC 1/3		YERI		DISTANCE:		LEG: 1	
TC 2/4		PETROFANI		33.08 km		SECTION: 1/2	
SPECIAL STAGE				1/3		AVERAGE	
Yeri				9.82 km		33.08 km/h	
						TIME ALLOWED: 60min	
DISTANCE		DIRECTION		INFORMATION		DISTANCE REGRESS.	
TOTAL	PARTIAL						
2.06	0.42			Tarmac		31.02	
		7.76					
2.15	0.09			Gravel		30.93	
		7.67					
2.47	0.32					30.61	
		7.35					
2.93	0.46					30.15	
		6.89					
3.81	0.88					29.27	
		6.01					
4.06	0.25					29.02	
		5.76					
						<div style="border: 1px solid black; padding: 2px;"> N35 05.290 E33 26.522 </div>	

TC 1/3		YERI		DISTANCE:		LEG: 1	
TC 2/4		PETROFANI		33.08 km		SECTION: 1/2	
SPECIAL STAGE				1/3		AVERAGE	
Yeri				9.82 km		33.08 km/h	
						TIME ALLOWED: 60min	
DISTANCE		DIRECTION		INFORMATION		DISTANCE REGRESS.	
TOTAL	PARTIAL						
4.99	0.93	 13 4.83		Tarmac		28.09	
5.44	0.45	 14 4.38				27.64	
6.04	0.60	 15 3.78				27.04	
6.35	0.31	 16 3.47		Gravel		26.73	
6.69	0.34	 17 3.13				26.39	
7.27	0.58	 18 2.55				25.81	

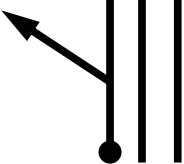
TC 1/3		YERI		DISTANCE:		LEG: 1	
TC 2/4		PETROFANI		33.08 km		SECTION: 1/2	
SPECIAL STAGE				1/3		AVERAGE	
Yeri				9.82 km		33.08 km/h	
						TIME ALLOWED: 60min	
DISTANCE		DIRECTION		INFORMATION		DISTANCE REGRESS.	
TOTAL	PARTIAL						
7.44	0.17					25.64	
		19	2.38				
7.47	0.03					25.61	
		20	2.35				
7.84	0.37					25.24	
		21	1.98				
8.15	0.31					24.93	
		22	1.67				
8.23	0.08			<p>! CAUTION !</p>		24.85	
		23	1.59	<div style="border: 1px solid black; padding: 2px;"> N35 03.716 E33 25.797 </div>			
8.49	0.26					24.59	
		24	1.33				

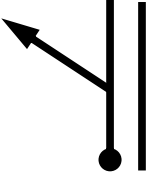
TC 1/3		YERI		DISTANCE:		LEG: 1	
TC 2/4		PETROFANI		33.08 km		SECTION: 1/2	
SPECIAL STAGE				1/3		AVERAGE	
Yeri				9.82 km		TIME ALLOWED: 60min	
DISTANCE		DIRECTION		INFORMATION		DISTANCE REGRESS.	
TOTAL	PARTIAL						
8.90	0.41					24.18	
9.53	0.63					23.55	
9.82	0.29			FINISH SS9/12 YERI <div style="border: 1px solid black; padding: 2px; width: fit-content; margin-top: 5px;"> N35 04.034 E33 25.065 </div>		23.26	
9.99	0.17			 Tarmac <div style="border: 1px solid black; padding: 2px; width: fit-content; margin-top: 5px;"> N35 04.002 E33 24.969 </div>		23.09	
10.17	0.18					22.91	
11.75	1.58			AYIOS ARTEMIOS CHURCH 		21.33	

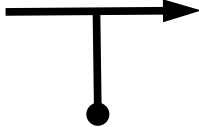
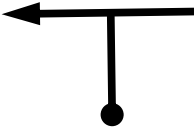
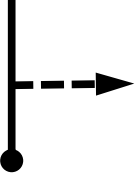
TC 1/3		YERI		DISTANCE:		LEG: 1	
TC 2/4		PETROFANI		33.08 km		SECTION: 1/2	
SPECIAL STAGE Yeri				1/3 9.82 km		AVERAGE 33.08 km/h	
						TIME ALLOWED: 60min	
DISTANCE		DIRECTION		INFORMATION		DISTANCE REGRESS.	
TOTAL	PARTIAL						
14.27	2.52			KYRIS MOTORS		18.81	
		31					
14.80	0.53					18.28	
		32					
14.92	0.12					18.16	
		33					
15.30	0.38			Join Motorway		17.78	
		34					
19.80	4.50					13.28	
		35		JOIN MOTORWAY TOWARDS LARNACA			
28.83	9.03			EXIT MOTORWAY ATHIENOU - KOSHI		4.25	
		36					

TC 1/3		YERI		DISTANCE:		LEG: 1	
TC 2/4		PETROFANI		33.08 km		SECTION: 1/2	
				AVERAGE		TIME ALLOWED:	
				33.08 km/h		60min	
DISTANCE		DIRECTION		INFORMATION		DISTANCE REGRESS.	
TOTAL	PARTIAL						
29.38	0.55					3.70	
31.00	1.62					2.08	
32.98	1.98			Gravel		0.10	
33.08	0.10					TC 2/4 PETROFANI	

TC 2/4	PETROFANI	DISTANCE:	LEG:	1
TC 2A/4A	REGROUPING IN	27.69 km	SECTION:	1/2
SPECIAL STAGE	2/4	AVERAGE	TIME ALLOWED:	
Petrofani	13.18 km	47.47 km/h		35 min

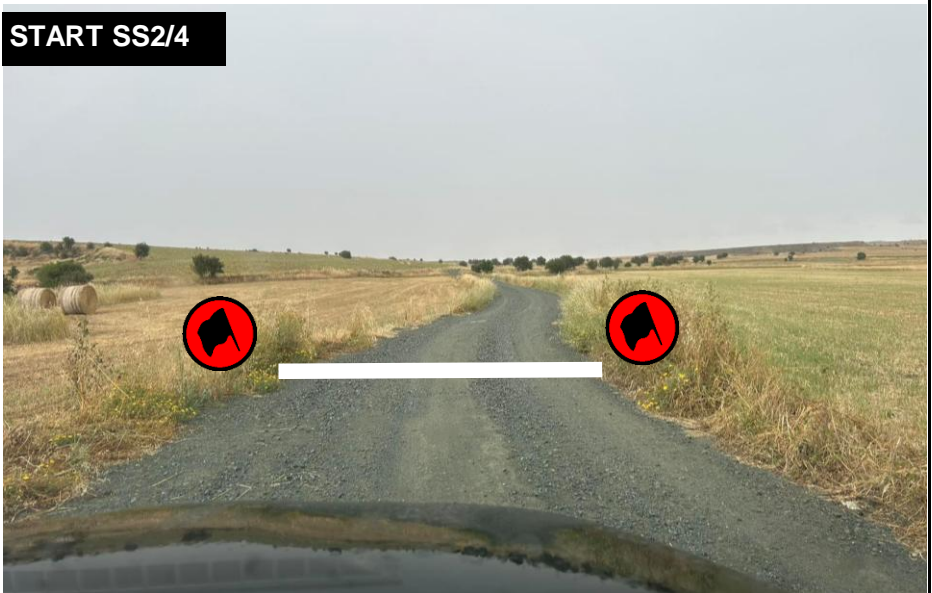
TC SS2/4**START SS2/4**





TC 2/4	PETROFANI	DISTANCE:	LEG:	1
TC 2A/4A	REGROUPING IN	27.69 km	SECTION:	1/2
SPECIAL STAGE	2/4	AVERAGE	TIME ALLOWED:	
Petrofani	13.18 km	47.47 km/h		35 min



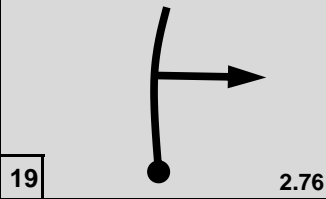
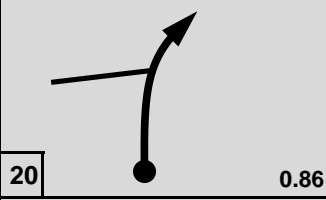
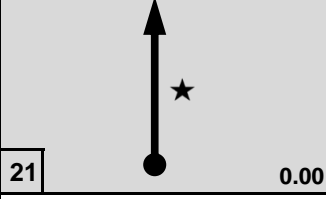

FINISH SS2/4**STOP SS2/4**

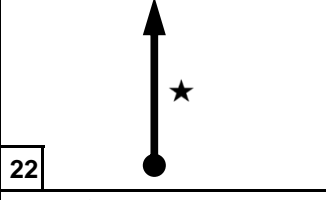
TC 2/4		PETROFANI		DISTANCE:	LEG:	1
TC 2A/4A		REGROUPING IN		27.69 km	SECTION:	1/2
SPECIAL STAGE				2/4	AVERAGE	TIME ALLOWED:
Petrofani				13.18 km	47.47 km/h	35 min
DISTANCE		DIRECTION	INFORMATION	DISTANCE REGRESS.		
TOTAL	PARTIAL					
0.00	0.00		START SS2/4 PETROFANI <div style="border: 1px solid black; padding: 2px; width: fit-content;"> N35 01.173 E33 29.786 </div>	27.69		
0.96	0.96			26.73		
1.96	1.00		TARMAC	25.73		
2.31	0.35			25.38		
2.66	0.35			25.03		
3.43	0.77			24.26		

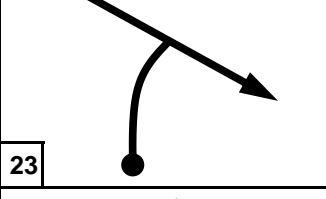
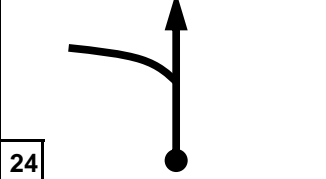

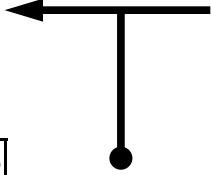
TC 2/4		PETROFANI		DISTANCE:	LEG:	1
TC 2A/4A		REGROUPING IN		27.69 km	SECTION:	1/2
SPECIAL STAGE				2/4	AVERAGE	TIME ALLOWED:
Petrofani				13.18 km	47.47 km/h	35 min
DISTANCE		DIRECTION		INFORMATION		DISTANCE REGRESS.
TOTAL	PARTIAL					
4.17	0.74	 7 9.01		TARMAC		23.52
4.75	0.58	 8 8.43		2 GRAVEL		22.94
		 9 8.22		<div style="border: 1px solid black; padding: 2px; width: fit-content;"> N35 00.809 E33 31.757 </div>		
4.96	0.21	 9 8.22				22.73
5.40	0.44	 10 7.78				22.29
5.91	0.51	 11 7.27				21.78
6.21	0.30	 12 6.97				21.48

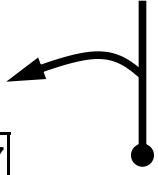
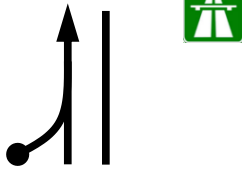
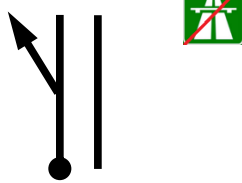

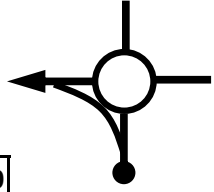

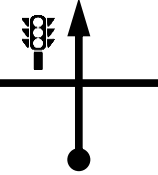
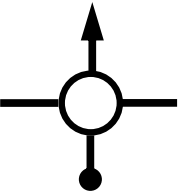
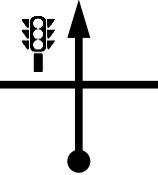
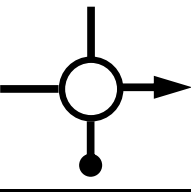
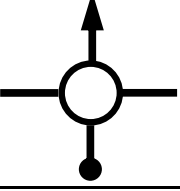
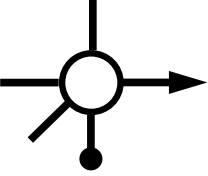

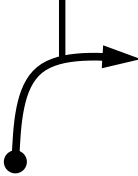
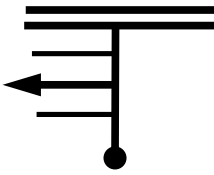
TC 2/4		PETROFANI		DISTANCE:	LEG:	1
TC 2A/4A		REGROUPING IN		27.69 km	SECTION:	1/2
SPECIAL STAGE				2/4	AVERAGE	TIME ALLOWED:
Petrofani				13.18 km	47.47 km/h	35 min
DISTANCE		DIRECTION	INFORMATION	DISTANCE REGRESS.		
TOTAL	PARTIAL					
6.46	0.25			21.23		
7.35	0.89			20.34		
7.63	0.28		OVER BRIDGE	20.06		
8.36	0.73			19.33		
9.11	0.75			18.58		
10.34	1.23		TARMAC	17.35		







TC 2/4		PETROFANI		DISTANCE:	LEG:	1	
TC 2A/4A		REGROUPING IN		27.69 km	SECTION:	1/2	
SPECIAL STAGE				2/4	AVERAGE	TIME ALLOWED:	
Petrofani				13.18 km	47.47 km/h	35 min	
DISTANCE		DIRECTION		INFORMATION		DISTANCE REGRESS.	
TOTAL	PARTIAL						
10.42	0.08	19				17.27	
12.32	1.90	20				15.37	
13.18	0.86	21		 FINISH SS2/4 PETROFANI	<div style="border: 1px solid black; padding: 2px;">N35 00.783 E33 34.339</div>	14.51	
13.43	0.25	22			 3	<div style="border: 1px solid black; padding: 2px;">N35 00.640 E33 34.329</div>	14.26
13.51	0.08	23		AVDELLERO VILLAGE		14.18	
13.69	0.18	24				14.00	

TC 2/4		PETROFANI		DISTANCE:	LEG:	1
TC 2A/4A		REGROUPING IN		27.69 km	SECTION:	1/2
SPECIAL STAGE				2/4	AVERAGE	TIME ALLOWED:
Petrofani				13.18 km	47.47 km/h	35 min
DISTANCE		DIRECTION		INFORMATION		DISTANCE REGRESS.
TOTAL	PARTIAL					
14.49	0.80	25				13.20
20.34	5.85	26			UNDER BRIDGE LAOS GARAGE	7.35
20.49	0.15	27				7.20
20.77	0.28	28			JOIN MOTORWAY	6.92
21.67	0.90	29				6.02
22.32	0.65	30			Take the 1st exit	5.37

TC 2/4		PETROFANI		DISTANCE:	LEG:	1
TC 2A/4A		REGROUPING IN		27.69 km	SECTION:	1/2
SPECIAL STAGE				2/4	AVERAGE	TIME ALLOWED:
Petrofani				13.18 km	47.47 km/h	35 min
DISTANCE		DIRECTION		INFORMATION		DISTANCE REGRESS.
TOTAL	PARTIAL					
23.64	1.32	31				4.05
24.51	0.87	32		Take the 2nd exit		3.18
25.31	0.80	33				2.38
26.19	0.88	34		Take the 3rd exit		1.50
26.54	0.35	35		Take the 2nd exit		1.15
27.07	0.53	36		Take the 4th exit		0.62







TC 2/4		PETROFANI		DISTANCE:	LEG:	1
TC 2A/4A		REGROUPING IN		27.69 km	SECTION:	1/2
				AVERAGE	TIME ALLOWED:	
				47.47 km/h		35 min
DISTANCE		DIRECTION	INFORMATION	DISTANCE REGRESS.		
TOTAL	PARTIAL					
27.42	0.35	 <div style="border: 1px solid black; padding: 2px; display: inline-block;">37</div>		0.27		
27.63	0.21	 <div style="border: 1px solid black; padding: 2px; display: inline-block;">38</div>		0.06		
27.69	0.06	 <div style="border: 1px solid black; padding: 2px; display: inline-block;">39</div>	 TC 2A/4A REGROUPING IN/ SERVICE IN <div style="border: 1px solid black; padding: 2px; display: inline-block; margin-top: 10px;"> N34 55.484 E33 36.043 </div>	0.00		

TC 2A/4A REGROUPING IN/ TECH. ZONE IN			LEG:	1
TC 2B/4B REGROUPING OUT / SERVICE IN			SECTION:	1/2
			TIME ALLOWED:	max 15 min
DISTANCE		DIRECTION	INFORMATION	DISTANCE REGRESS.
TOTAL	PARTIAL			
		 	 <p>TC 2A/4A REGROUPING IN</p> <div style="border: 1px solid black; padding: 2px; width: fit-content; margin-left: auto;"> N34 55.484 E33 36.043 </div>	
		 	 <p>TC 2B/4B REGROUPING OUT & SERVICE IN</p> <div style="border: 1px solid black; padding: 2px; width: fit-content; margin-left: auto;"> N34 55.498 E33 36.054 </div>	

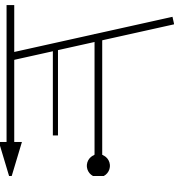

TC 2B/4B REGROUPING OUT / SERVICE IN			LEG:	1
TC 2C/4C SERVICE OUT			SECTION:	1/2
			TIME ALLOWED SERVICE:	30 min
DISTANCE		DIRECTION	INFORMATION	DISTANCE REGRESS.
TOTAL	PARTIAL			
		  <div style="border: 1px solid black; padding: 2px; width: 20px; margin: 0 auto;">1</div>	 TC 2B/4B REGROUPING OUT & SERVICE IN <div style="border: 1px solid black; padding: 2px; width: 100px; margin: 0 auto;"> N34 55.498 E33 36.054 </div>	
		  <div style="border: 1px solid black; padding: 2px; width: 20px; margin: 0 auto;">2</div>	 TC 2C/4C SERVICE OUT <div style="border: 1px solid black; padding: 2px; width: 100px; margin: 0 auto;"> N34 55.475 E33 36.053 </div>	

FOR TC2C -> TC3 TURN BACK TO PAGE 1

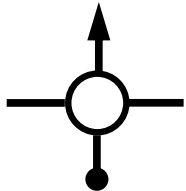
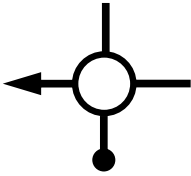
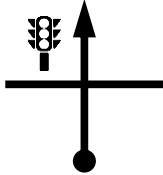
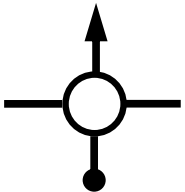
FOR TC4C -> TC5 TURN TO PAGE 28

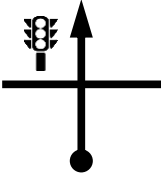
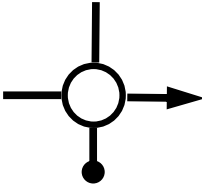
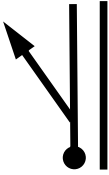
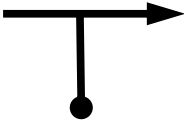
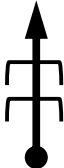
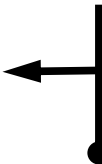
TC4C SERVICE OUT		DISTANCE:		LEG:	1
TC 5 SSS ATHIENOU		14.39 km		SECTION:	3
		AVERAGE		TIME ALLOWED:	
		34.54 km/h		25 min	
DISTANCE		DIRECTION	INFORMATION	DISTANCE REGRESS.	
TOTAL	PARTIAL				
0.00	0.00	<div style="text-align: center;">  </div>	 <p>TC 4C SERVICE OUT</p> <div style="border: 1px solid black; padding: 2px; width: fit-content; margin: 5px auto;"> N34 55.004 E33 38.288 </div>	14.39	
		1			
0.07	0.07	<div style="text-align: center;">  </div>	  	14.32	
		2			
0.33	0.26	<div style="text-align: center;">  </div>	MALL	14.06	
		3			
0.65	0.32	<div style="text-align: center;">  </div>	Take the 1st exit	13.74	
		4			
1.50	0.85	<div style="text-align: center;">  </div>		12.89	
		5			
2.23	0.73	<div style="text-align: center;">  </div>	Take the 2nd exit	12.16	
		6			

TC4C SERVICE OUT		DISTANCE:		LEG:	1
TC 5 SSS ATHIENOU		14.39 km		SECTION:	3
		AVERAGE		TIME ALLOWED:	
		34.54 km/h		25 min	
DISTANCE		DIRECTION	INFORMATION	DISTANCE REGRESS.	
TOTAL	PARTIAL				
3.15	0.92	<div style="text-align: center;">  </div>			11.24
		7			
4.56	1.41	<div style="text-align: center;">  </div>	Take the 3rd exit (Rizoelia)		9.83
		8			
6.14	1.58	<div style="text-align: center;">  </div>			8.25
		9			
6.52	0.38	<div style="text-align: center;">  </div>			7.87
		10			
13.88	7.36	<div style="text-align: center;">  </div>	UNDER BRIDGE		0.51
		11			
14.23	0.35	<div style="text-align: center;">  </div>			0.16
		12			

TC4C SERVICE OUT		DISTANCE:		LEG:	1	
TC 5 SSS ATHIENOU		14.39 km		SECTION:	3	
		AVERAGE		TIME ALLOWED:		
		34.54 km/h		25 min		
DISTANCE		DIRECTION		INFORMATION		DISTANCE REGRESS.
TOTAL	PARTIAL					
14.39	0.16			<p style="text-align: center;">TC 5 SSS ATHIENOU</p>  <div style="border: 1px solid black; padding: 2px; width: fit-content; margin: 0 auto;"> N35.0248919 E33.5521559 </div>		0.00
	13					

TC 5	SSS ATHIENOU	DISTANCE:	LEG:	1
TC 5A	TECHNICAL ZONE IN	17.55 km	SECTION:	3
SPECIAL STAGE	5	AVERAGE	TIME ALLOWED:	
SSS ATHIENOU	2.07 km	30.09 km/h		35 min



TC 5	SSS ATHIENOU	DISTANCE:	LEG:	1
TC 5A	TECHNICAL ZONE IN	17.55 km	SECTION:	3
SPECIAL STAGE	5	AVERAGE	TIME ALLOWED:	
SSS ATHIENOU	2.07 km	30.09 km/h		35 min

TC SS5



START SS5











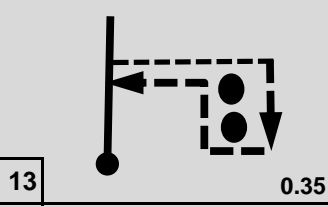
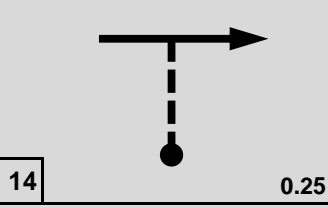
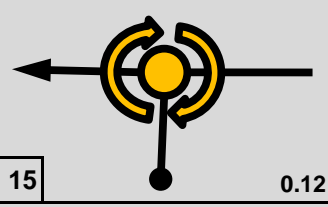

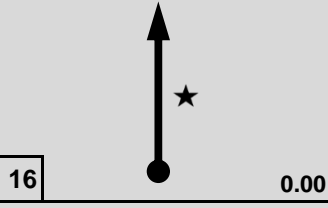
TC 5	SSS ATHIENOU	DISTANCE:	LEG:	1
TC 5A	TECHNICAL ZONE IN	17.55 km	SECTION:	3
SPECIAL STAGE		5	AVERAGE	TIME ALLOWED:
SSS ATHIENOU		2.07 km	30.09 km/h	35 min

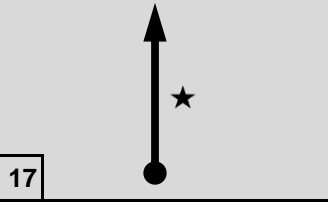

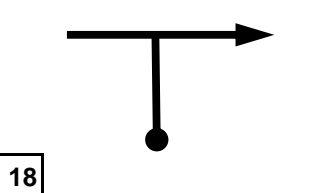
TC 5		SSS ATHIENOU		DISTANCE:	LEG:	1
TC 5A		TECHNICAL ZONE IN		17.55 km	SECTION:	3
SPECIAL STAGE				5	AVERAGE	TIME ALLOWED:
SSS ATHIENOU		2.07 km		30.09 km/h	35 min	
DISTANCE		DIRECTION		INFORMATION		DISTANCE REGRESS.
TOTAL	PARTIAL					
0.00	0.00	1		<p>START SS5 SSS ATHIENOU</p> <div style="border: 1px solid black; padding: 2px; display: inline-block;"> N35.0248919 E33.5521559 </div>	17.55	
0.05	0.05	2			17.50	
0.20	0.15	3		GRAVEL	17.35	
0.49	0.29	4			17.06	
0.61	0.12	5		TARMAC	16.94	
0.69	0.08	6			16.86	

TC 5		SSS ATHIENOU		DISTANCE:	LEG:	1
TC 5A		TECHNICAL ZONE IN		17.55 km	SECTION:	3
SPECIAL STAGE				5	AVERAGE	TIME ALLOWED:
SSS ATHIENOU				2.07 km	30.09 km/h	35 min
DISTANCE		DIRECTION	INFORMATION	DISTANCE REGRESS.		
TOTAL	PARTIAL					
0.84	0.15	 7 1.23	GRAVEL	16.71		
0.93	0.09	 8 1.14	GRAVEL	16.62		
1.04	0.11	 9 1.03		16.51		
1.22	0.18	 10 0.85	TARMAC	16.33		
1.31	0.09	 11 0.76		16.24		
1.51	0.20	 12 0.56		16.04		

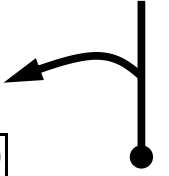
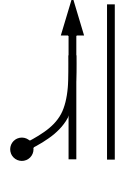
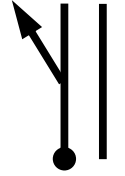

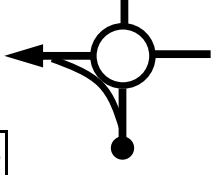
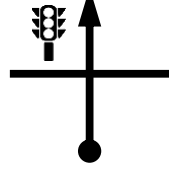
TC 5		SSS ATHIENOU		DISTANCE:	LEG:	1
TC 5A		TECHNICAL ZONE IN		17.55 km	SECTION:	3
SPECIAL STAGE				5	AVERAGE	TIME ALLOWED:
SSS ATHIENOU		2.07 km		30.09 km/h	35 min	
DISTANCE		DIRECTION	INFORMATION	DISTANCE REGRESS.		
TOTAL	PARTIAL					
1.72	0.21		GRAVEL	15.83		
1.82	0.10		TARMAC	15.73		
1.95	0.13			15.60		
2.07	0.12		 FINISH SS5 <div style="border: 1px solid black; padding: 2px; width: fit-content; margin-left: auto; margin-right: auto;"> N35 00.783 E33 34.339 </div>	15.48		
2.20	0.13		  <div style="border: 1px solid black; padding: 2px; width: fit-content; margin-left: auto; margin-right: auto;"> N35 00.640 E33 34.329 </div>	15.35		
2.30	0.10			15.25		
		18				

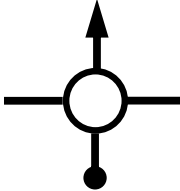
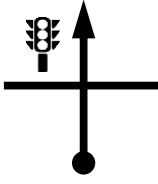
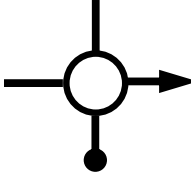
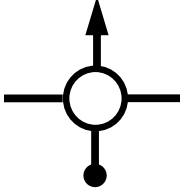
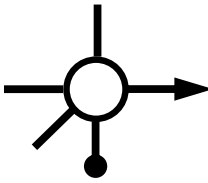



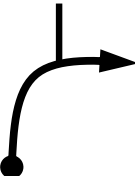
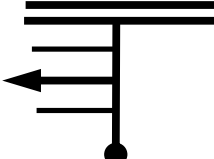

TC 5		SSS ATHIENOU		DISTANCE:	LEG:	1
TC 5A		TECHNICAL ZONE IN		17.55 km	SECTION:	3
SPECIAL STAGE				5	AVERAGE	TIME ALLOWED:
SSS ATHIENOU		2.07 km		30.09 km/h	35 min	
DISTANCE		DIRECTION	INFORMATION	DISTANCE REGRESS.		
TOTAL	PARTIAL					
10.20	7.90	19 	UNDER BRIDGE LAOS GARAGE	7.35		
10.35	0.15	20 		7.20		
10.63	0.28	21 	JOIN MOTORWAY	6.92		
11.53	0.90	22  		6.02		
12.18	0.65	23 	Take the 1st exit	5.37		
13.50	1.32	24 		4.05		







TC 5		SSS ATHIENOU		DISTANCE:		LEG:		1	
TC 5A		TECHNICAL ZONE IN		17.55 km		SECTION:		3	
SPECIAL STAGE				5		AVERAGE		TIME ALLOWED:	
SSS ATHIENOU				2.07 km		30.09 km/h		35 min	
DISTANCE		DIRECTION			INFORMATION			DISTANCE REGRESS.	
TOTAL	PARTIAL								
14.37	0.87				Take the 2nd exit			3.18	
		25							
15.17	0.80							2.38	
		26							
16.05	0.88				Take the 3rd exit			1.50	
		27							
16.40	0.35				Take the 2nd exit			1.15	
		28							
16.93	0.53				Take the 4th exit			0.62	
		29							







PAGE 39







TC 5		SSS ATHIENOU		DISTANCE:		LEG:		1	
TC 5A		TECHNICAL ZONE IN		17.55 km		SECTION:		3	
				AVERAGE		TIME ALLOWED:			
				30.09 km/h		35 min			
DISTANCE		DIRECTION			INFORMATION			DISTANCE REGRESS.	
TOTAL	PARTIAL								





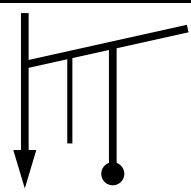

17.28	0.35	<div data-bbox="300 236 341 279" style="border: 1px solid black; padding: 2px;">30</div> 		0.27
17.49	0.21	<div data-bbox="300 443 341 486" style="border: 1px solid black; padding: 2px;">31</div> 		0.06
17.55	0.06	<div data-bbox="300 651 341 694" style="border: 1px solid black; padding: 2px;">32</div> 	 <p>TC 5A TECHNICAL ZONE IN</p> <div data-bbox="812 622 946 694" style="border: 1px solid black; padding: 5px; width: fit-content;"><p>N34 55.484 E33 36.043</p></div>	0.00

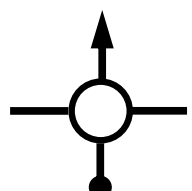
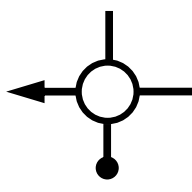
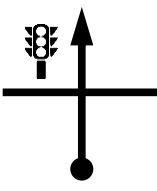
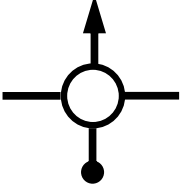
TC 5A TECH ZONE IN			LEG:	1
TC 5B TECH ZONE OUT-SERVICE IN			SECTION:	3
			TIME ALLOWED SERVICE:	3 min
DISTANCE		DIRECTION	INFORMATION	DISTANCE REGRESS.
TOTAL	PARTIAL			
		 	 TC 5A TECH ZONE IN <div style="border: 1px solid black; padding: 2px; width: fit-content; margin: 10px auto;"> N34 55.498 E33 36.054 </div>	
		 	 TC 5B TECH ZONE OUT SERVICE IN <div style="border: 1px solid black; padding: 2px; width: fit-content; margin: 10px auto;"> N34 55.475 E33 36.053 </div>	

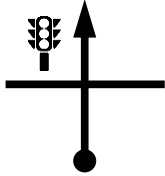
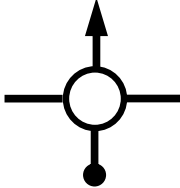
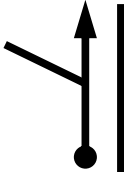
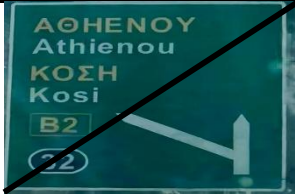
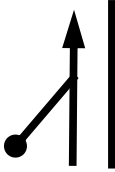
TC 5B SERVICE IN			LEG:	1
TC 5C SERVICE OUT/ PARK FERME IN			SECTION:	3
			TIME ALLOWED SERVICE:	45 min
DISTANCE		DIRECTION	INFORMATION	DISTANCE REGRESS.
TOTAL	PARTIAL			
		  <div style="border: 1px solid black; display: inline-block; padding: 2px;">1</div>	 TC 5B SERVICE IN <div style="border: 1px solid black; display: inline-block; padding: 2px;">N34 55.498 E33 36.054</div>	
		  <div style="border: 1px solid black; display: inline-block; padding: 2px;">2</div>	 TC 5C SERVICE OUT/ PARK FERME IN <div style="border: 1px solid black; display: inline-block; padding: 2px;">N34 55.475 E33 36.053</div>	

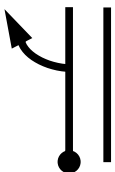
TC 5D PARC FERME OUT-SERVICE IN			LEG:	2
TC 5E SERVICE OUT			SECTION:	4
			TIME ALLOWED SERVICE:	15 min
DISTANCE		DIRECTION	INFORMATION	DISTANCE REGRESS.
TOTAL	PARTIAL			
		 	 TC 5D PARC FERME OUT SERVICE IN <div style="border: 1px solid black; padding: 2px; width: fit-content; margin: 5px auto;"> N34 55.498 E33 36.054 </div>	
		 	 TC 5E SERVICE OUT <div style="border: 1px solid black; padding: 2px; width: fit-content; margin: 5px auto;"> N34 55.475 E33 36.053 </div>	

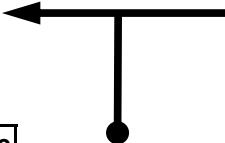
TC5E SERVICE OUT		DISTANCE:		LEG:	2
TC6 KOTSIATIS		31.56 km		SECTION:	4
		AVERAGE		TIME ALLOWED:	
		37.87 km/h		50 min	
DISTANCE		DIRECTION	INFORMATION	DISTANCE REGRESS.	
TOTAL	PARTIAL				
0.00	0.00		 <p>TC 5E SERVICE OUT</p> <div style="border: 1px solid black; padding: 2px; width: fit-content;"> N34 55.004 E33 38.288 </div>	31.56	
		1			
0.07	0.07		  	31.49	
		2			
0.33	0.26		MALL	31.23	
		3			
0.65	0.32		Take the 1st exit	30.91	
		4			
1.50	0.85			30.06	
		5			
2.23	0.73		Take the 2nd exit	29.33	
		6			

TC5E SERVICE OUT		DISTANCE:		LEG: 2	
TC6 KOTSIATIS		31.56 km		SECTION: 4	
		AVERAGE 37.87 km/h		TIME ALLOWED: 50 min	
DISTANCE		DIRECTION	INFORMATION	DISTANCE REGRESS.	
TOTAL	PARTIAL				
3.15	0.92				28.41
		7			
4.56	1.41		Take the 2nd exit Join motorway (Rizoelia)		27.00
		8			
9.90	5.34				21.66
		9			
23.77	13.87		JOIN MOTORWAY LIMASSOL - NICOSIA		7.79
		10			
25.85	2.08				5.71
		11			
25.94	0.09				5.62
		12			

TC5E SERVICE OUT		DISTANCE:		LEG:	2
TC6 KOTSIATIS		31.56 km		SECTION:	4
		AVERAGE		TIME ALLOWED:	
		37.87 km/h		50 min	
DISTANCE		DIRECTION	INFORMATION	DISTANCE REGRESS.	
TOTAL	PARTIAL				
28.76	2.82			2.80	
29.49	0.73			2.07	
29.82	0.33			1.74	
31.56	1.74		<p>TC 6 KOTSIATIS</p> <div style="border: 1px solid black; padding: 2px; display: inline-block;"> N34 59.860 E33 20.863 </div>	0.00	

TC 6	KOTSIATIS	DISTANCE:	LEG:	2
TC 6A	HOLDING CONTROL IN	19.29 km	SECTION:	4
SPECIAL STAGE	6	AVERAGE	TIME ALLOWED:	
Kotsiatis	13.64 km	38.58 km/h		30 min

TC SS6

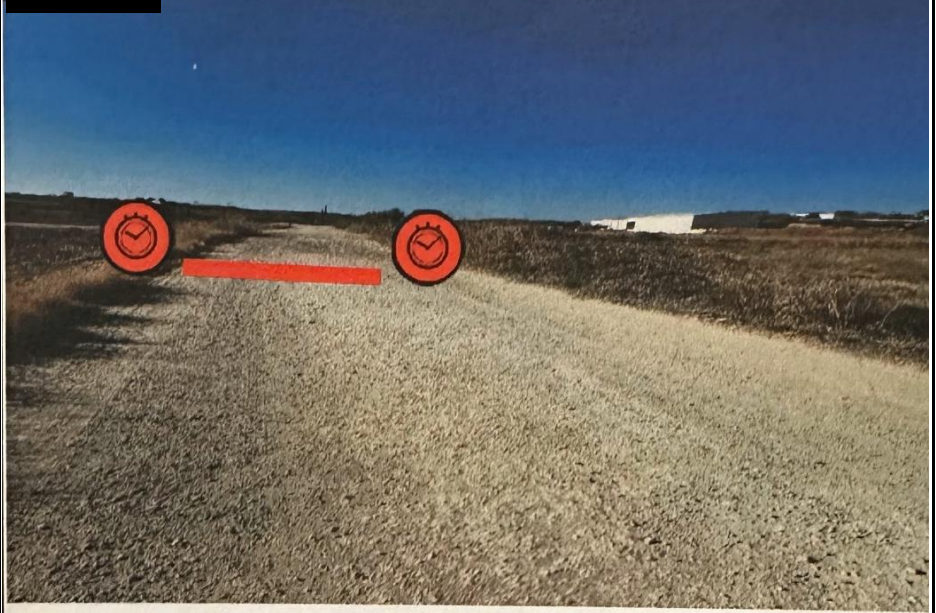

START SS6

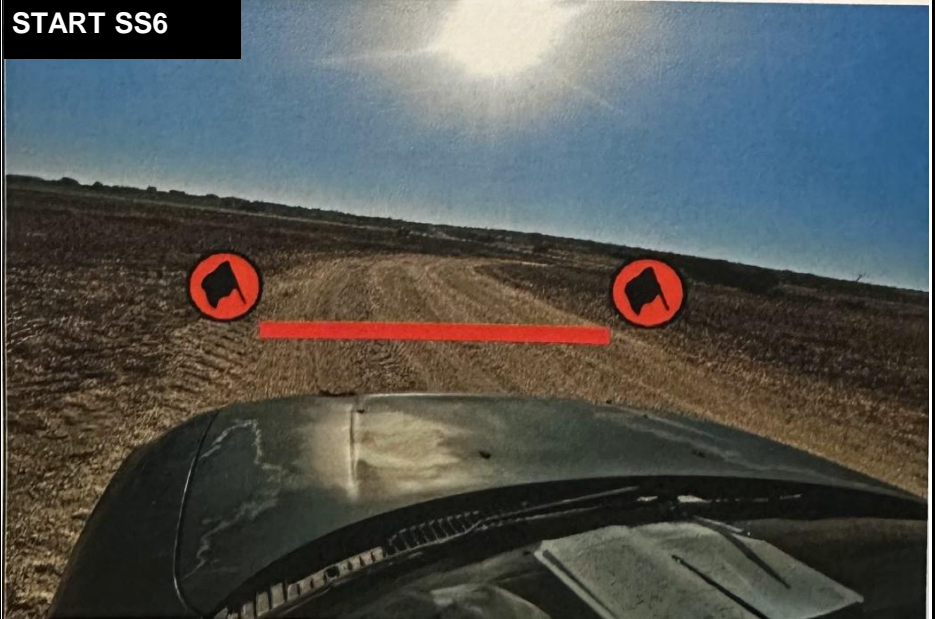

TC 6	KOTSIATIS	DISTANCE:	LEG:	2
TC 6A	HOLDING CONTROL IN	19.29 km	SECTION:	4
SPECIAL STAGE	6	AVERAGE	TIME ALLOWED:	
Kotsiatis	13.64 km	38.58 km/h		30 min

FINISH SS6



STOP SS6



TC 6		KOTSIATIS		DISTANCE:	LEG:	2
TC 6A		HOLDING CONTROL IN		19.29 km	SECTION:	4
SPECIAL STAGE				6	AVERAGE	TIME ALLOWED:
Kotsiatis				13.64 km	38.58 km/h	30 min
DISTANCE		DIRECTION		INFORMATION		DISTANCE REGRESS.
TOTAL	PARTIAL					
0.00	0.00	1		 	START SS6 KOTSIATIS N34 59.925 E33 20.869	19.29
0.27	0.27	2				19.02
0.47	0.20	3				18.82
0.92	0.45	4				18.37
1.70	0.78	5				17.59
2.35	0.65	6				16.94



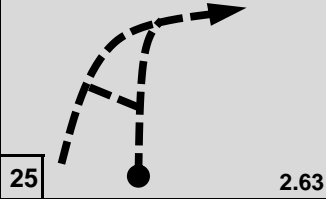
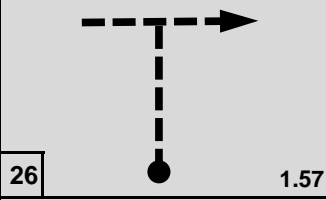
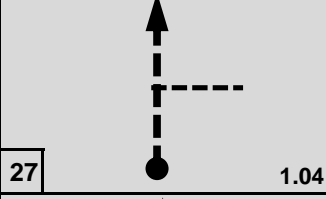
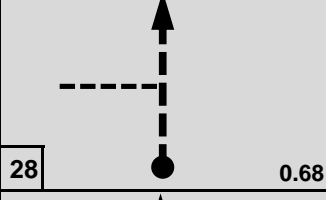
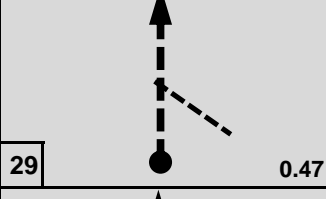
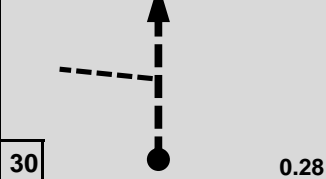

TC 6		KOTSIATIS		DISTANCE:	LEG:	2
TC 6A		HOLDING CONTROL IN		19.29 km	SECTION:	4
SPECIAL STAGE				6	AVERAGE	TIME ALLOWED:
Kotsiatis				13.64 km	38.58 km/h	30 min
DISTANCE		DIRECTION	INFORMATION	DISTANCE REGRESS.		
TOTAL	PARTIAL					
2.85	0.50			16.44		
3.04	0.19			16.25		
4.27	1.23		ER Evacuation Road <div style="border: 1px solid black; padding: 2px; display: inline-block;"> N34 58.190 E33 20.335 </div>	15.02		
5.27	1.00			14.02		
5.57	0.30			13.72		
5.82	0.25			13.47		

TC 6		KOTSIATIS		DISTANCE:	LEG:	2
TC 6A		HOLDING CONTROL IN		19.29 km	SECTION:	4
SPECIAL STAGE				6	AVERAGE	TIME ALLOWED:
Kotsiatis				13.64 km	38.58 km/h	30 min
DISTANCE		DIRECTION	INFORMATION	DISTANCE REGRESS.		
TOTAL	PARTIAL					
5.92	0.10			13.37		
6.15	0.23			13.14		
6.45	0.30			12.84		
6.75	0.30			12.54		
7.17	0.42			12.12		
7.23	0.06			<div style="border: 1px solid black; padding: 2px;"> N34 59.719 E33 19.814 </div>		

TC 6		KOTSIATIS		DISTANCE:	LEG:	2
TC 6A		HOLDING CONTROL IN		19.29 km	SECTION:	4
SPECIAL STAGE				6	AVERAGE	TIME ALLOWED:
Kotsiatis				13.64 km	38.58 km/h	30 min
DISTANCE		DIRECTION		INFORMATION		DISTANCE REGRESS.
TOTAL	PARTIAL					
7.67	0.44					11.62
8.19	0.52					11.10
8.60	0.41					10.69
9.31	0.71					9.98
9.48	0.17					9.81
9.60	0.12					9.69

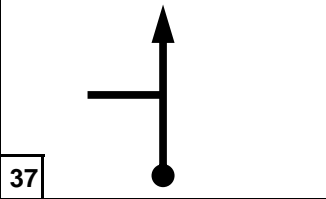
TC 6		KOTSIATIS		DISTANCE:	LEG:	2
TC 6A		HOLDING CONTROL IN		19.29 km	SECTION:	4
SPECIAL STAGE				6	AVERAGE	TIME ALLOWED:
Kotsiatis				13.64 km	38.58 km/h	30 min
DISTANCE		DIRECTION		INFORMATION		DISTANCE REGRESS.
TOTAL	PARTIAL					
11.01	1.41	25				8.28
12.07	1.06	26				7.22
12.60	0.53	27				6.69
12.96	0.36	28				6.33
13.17	0.21	29				6.12
13.36	0.19	30				5.93

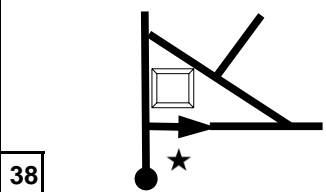
TC 6		KOTSIATIS		DISTANCE:	LEG:	2
TC 6A		HOLDING CONTROL IN		19.29 km	SECTION:	4
SPECIAL STAGE				6	AVERAGE	TIME ALLOWED:
Kotsiatis				13.64 km	38.58 km/h	30 min
DISTANCE		DIRECTION		INFORMATION		DISTANCE REGRESS.
TOTAL	PARTIAL					
13.64	0.28	31			FINISH SS6 KOTSIATIS	5.65
			0.00		N35 00.313 E33 18.438	
13.91	0.27	32				5.38
					N35 00.432 E33 18.555	
14.12	0.21	33			TARMAC	5.17
16.45	2.33	34				2.84
16.53	0.08	35				2.76
16.61	0.08	36				2.68

TC 6		KOTSIATIS		DISTANCE:	LEG:	2
TC 6A		HOLDING CONTROL IN		19.29 km	SECTION:	4
SPECIAL STAGE				6	AVERAGE	TIME ALLOWED:
Kotsiatis				13.64 km	38.58 km/h	30 min
DISTANCE		DIRECTION	INFORMATION	DISTANCE REGRESS.		
TOTAL	PARTIAL					
18.89	2.28			0.40		
19.29	0.40		TC 6A HOLDING CONTROL IN 	0.00		



TC 6A	HOLDING CONTROL IN	DISTANCE:	LEG:	2
TC 6B	HOLDING CONTROL OUT		SECTION:	4
SPECIAL STAGE		AVERAGE	TIME ALLOWED:	



TC 6A HOLDING CONTROL IN			LEG:	2
TC 6B HOLDING CONTROL OUT			SECTION:	4
			TIME ALLOWED:	50 min
DISTANCE		DIRECTION	INFORMATION	DISTANCE REGRESS.
TOTAL	PARTIAL			
			 TC 6A HOLDING CONTROL IN	
			 TC 6B HOLDING CONTROL OUT	

TC6B		HOLDING CONTROL OUT		DISTANCE:	LEG:	2
TC7		KOTSIATIS		2.15 km	SECTION:	4
				AVERAGE	TIME ALLOWED:	10 min
				12.90 km/h		
DISTANCE		DIRECTION	INFORMATION	DISTANCE REGRESS.		
TOTAL	PARTIAL					
0.00	0.00		<p>TC 6B HOLDING CONTROL OUT</p>	2.15		
		1				
0.08	0.08			2.07		
		2				
0.41	0.33			1.74		
		3				
2.15	1.74		<p>TC 7 KOTSIATIS</p> <div style="border: 1px solid black; padding: 2px; display: inline-block;"> N34 59.860 E33 20.863 </div>	0.00		
		4				

TC 7 KOTSIATIS	DISTANCE:	LEG:	2
TC 7A Regrouping IN & Tech. Zone IN	50.96 km	SECTION:	4
SPECIAL STAGE	7	AVERAGE	TIME ALLOWED:
Kotsiatis	13.64 km	50.96 km/h	60 min

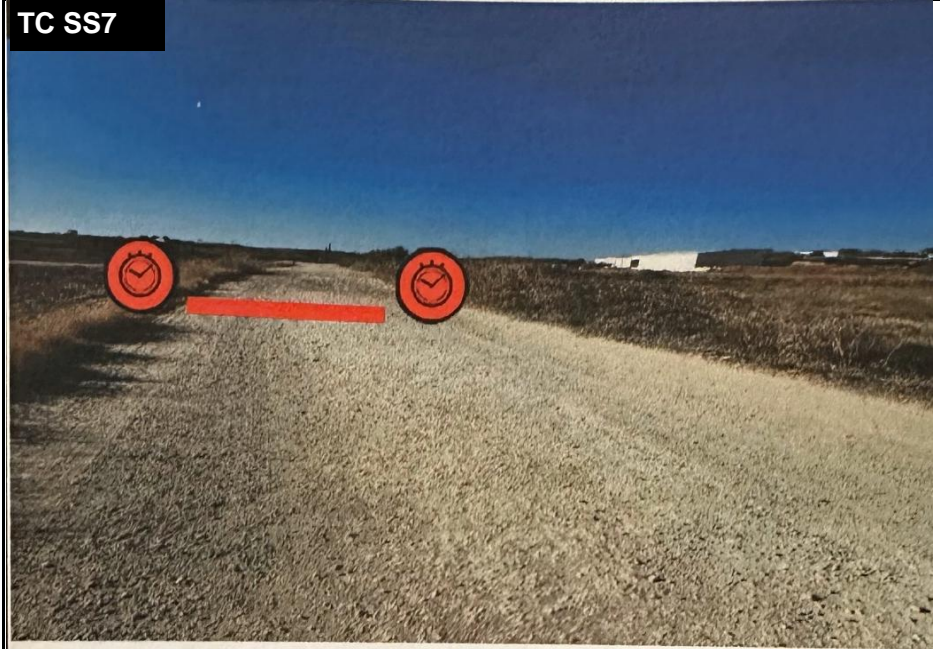

TC 7 KOTSIATIS	DISTANCE:	LEG:	2
TC 7A Regrouping IN & Tech. Zone IN	50.96 km	SECTION:	4
SPECIAL STAGE	7	AVERAGE	TIME ALLOWED:
Kotsiatis	13.64 km	50.96 km/h	60 min



FINISH SS7



STOP SS7

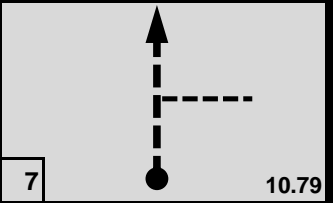
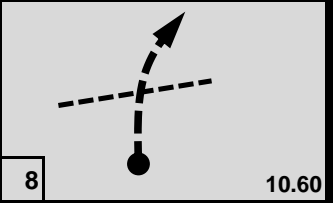
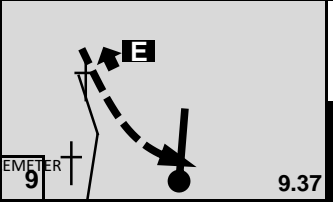

TC 7 KOTSIATIS		DISTANCE:		LEG: 2	
TC 7A Regrouping IN & Tech. Zone IN		50.96 km		SECTION: 4	
SPECIAL STAGE		7		AVERAGE	
Kotsiatis		13.64 km		TIME ALLOWED: 60 min	
DISTANCE		DIRECTION		INFORMATION	
TOTAL	PARTIAL			DISTANCE REGRESS.	
0.00	0.00			<p>START SS7 KOTSIATIS</p> <div style="border: 1px solid black; padding: 2px; display: inline-block;"> N34 59.925 E33 20.869 </div>	
0.27	0.27			50.96	
0.47	0.20			50.69	
0.92	0.45			50.49	
1.70	0.78			50.04	
2.35	0.65			49.26	
				48.61	

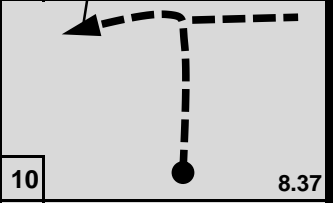
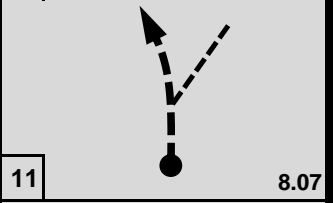
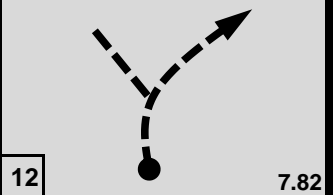





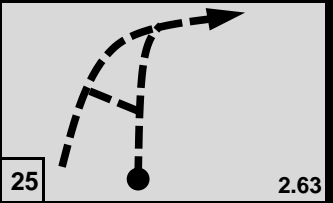
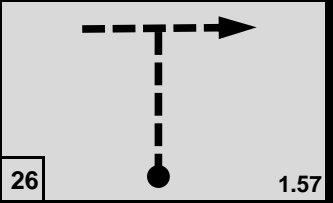
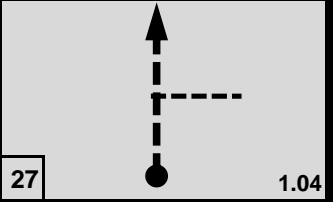
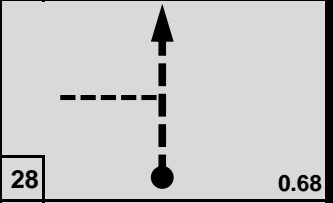
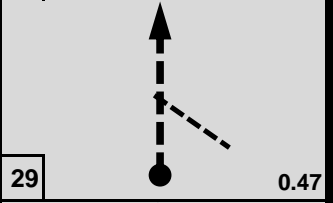
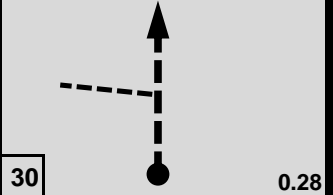



TC 7 KOTSIATIS		DISTANCE:		LEG:	2
TC 7A Regrouping IN & Tech. Zone IN		50.96 km		SECTION:	4
SPECIAL STAGE		7		AVERAGE	TIME ALLOWED:
Kotsiatis		13.64 km		50.96 km/h	60 min
DISTANCE		DIRECTION	INFORMATION	DISTANCE REGRESS.	
TOTAL	PARTIAL				
2.85	0.50			48.11	
3.04	0.19			47.92	
4.27	1.23		ER Evacuation Road  2 N34 58.190 E33 20.335	46.69	
5.27	1.00			45.69	
5.57	0.30			45.39	
5.82	0.25			45.14	

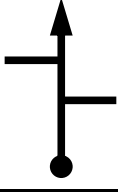

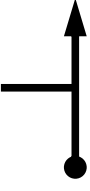
TC 7 KOTSIATIS		DISTANCE:		LEG: 2	
TC 7A Regrouping IN & Tech. Zone IN		50.96 km		SECTION: 4	
SPECIAL STAGE 7		AVERAGE		TIME ALLOWED:	
Kotsiatis		13.64 km		50.96 km/h	
DISTANCE		DIRECTION		INFORMATION	
TOTAL	PARTIAL			DISTANCE REGRESS.	
5.92	0.10			45.04	
6.15	0.23			44.81	
6.45	0.30			44.51	
6.75	0.30			44.21	
7.17	0.42			43.79	
7.23	0.06				
				<div style="border: 1px solid black; padding: 2px; display: inline-block;"> N34 59.719 E33 19.814 </div>	

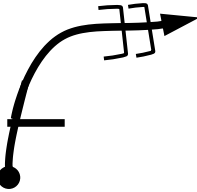
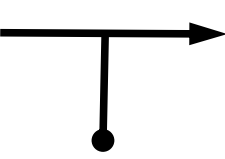

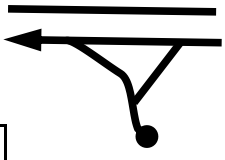
TC 7 KOTSIATIS		DISTANCE:		LEG:	2
TC 7A Regrouping IN & Tech. Zone IN		50.96 km		SECTION:	4
SPECIAL STAGE			7	AVERAGE	TIME ALLOWED:
Kotsiatis			13.64 km	50.96 km/h	60 min
DISTANCE		DIRECTION	INFORMATION	DISTANCE REGRESS.	
TOTAL	PARTIAL				
7.67	0.44			43.29	
		19	5.97		
8.19	0.52			42.77	
		20	5.45		
8.60	0.41			42.36	
		21	5.04		
9.31	0.71			41.65	
		22	4.33		
9.48	0.17			41.48	
		23	4.16		
9.60	0.12			41.36	
		24	4.04		



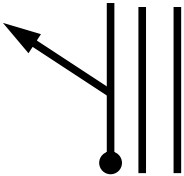

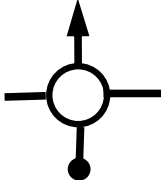
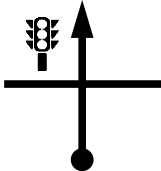
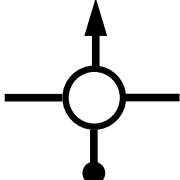
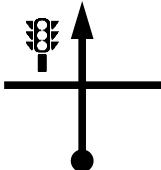
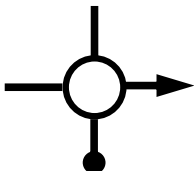

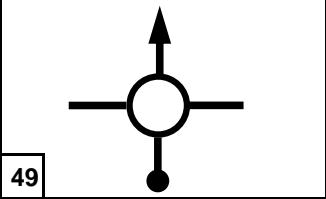
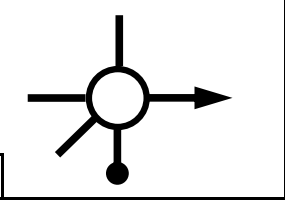
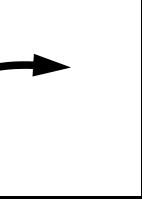
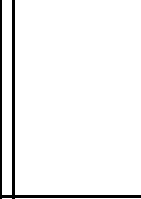
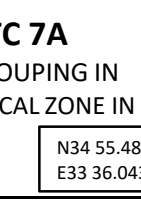
TC 7 KOTSIATIS		DISTANCE:	LEG:	2
TC 7A Regrouping IN & Tech. Zone IN		50.96 km	SECTION:	4
SPECIAL STAGE		7	AVERAGE	TIME ALLOWED:
Kotsiatis		13.64 km	50.96 km/h	60 min
DISTANCE		DIRECTION	INFORMATION	DISTANCE REGRESS.
TOTAL	PARTIAL			
11.01	1.41			39.95
12.07	1.06			38.89
12.60	0.53			38.36
12.96	0.36			38.00
13.17	0.21			37.79
13.36	0.19			37.60







TC 7 KOTSIATIS			DISTANCE:	LEG:	2
TC 7A Regrouping IN & Tech. Zone IN			50.96 km	SECTION:	4
SPECIAL STAGE			AVERAGE	TIME ALLOWED:	
Kotsiatis			13.64 km	50.96 km/h	60 min
DISTANCE		DIRECTION	INFORMATION	DISTANCE REGRESS.	
TOTAL	PARTIAL				
13.64	0.28		FINISH SS6 KOTSIATIS <div style="border: 1px solid black; padding: 2px; display: inline-block;"> N35 00.313 E33 18.438 </div>	37.32	
13.91	0.27		 <div style="border: 1px solid black; padding: 2px; display: inline-block;"> N35 00.432 E33 18.555 </div>	37.05	
14.12	0.21		TARMAC	36.84	
16.45	2.33			34.51	
16.53	0.08			34.43	
16.61	0.08			34.35	







TC 7 KOTSIATIS		DISTANCE:	LEG:	2
TC 7A Regrouping IN & Tech. Zone IN		50.96 km	SECTION:	4
SPECIAL STAGE		7	AVERAGE	TIME ALLOWED:
Kotsiatis		13.64 km	50.96 km/h	60 min
DISTANCE		DIRECTION	INFORMATION	DISTANCE REGRESS.
TOTAL	PARTIAL			
18.89	2.28			32.07
		37		
19.37	0.48			31.59
		38		
20.07	0.70			30.89
		39		
22.63	2.56			28.33
		40		
23.15	0.52			27.81
		41		
23.27	0.12			27.69
		42	JOIN MOTORWAY	





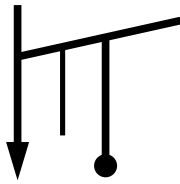

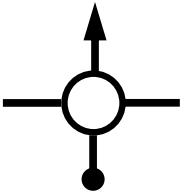
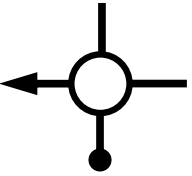
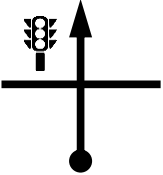
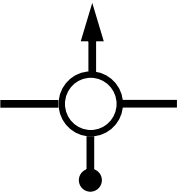

TC 7		KOTSIATIS		DISTANCE:	LEG:	2
TC 7A		Regrouping IN & Tech. Zone IN		50.96 km	SECTION:	4
SPECIAL STAGE				7	AVERAGE	TIME ALLOWED:
Kotsiatis				13.64 km	50.96 km/h	60 min
DISTANCE		DIRECTION	INFORMATION	DISTANCE REGRESS.		
TOTAL	PARTIAL					
25.59	2.32		 JOIN MOTORWAY TOWARDS LARNACA	25.37		
		43				
45.59	20.00		Take the 2ND exit RIZOELIA	5.37		
		44				
46.91	1.32			4.05		
		45				
47.78	0.87		Take the 2nd exit	3.18		
		46				
48.58	0.80			2.38		
		47				
49.46	0.88		Take the 3rd exit	1.50		
		48				

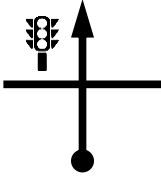
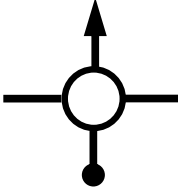
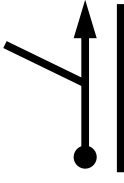

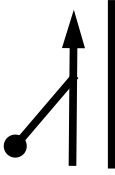

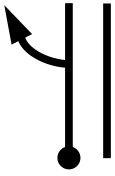

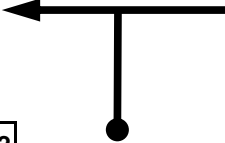



TC 7 KOTSIATIS		DISTANCE:		LEG:	2
TC 7A Regrouping IN & Tech. Zone IN		50.96 km		SECTION:	4
SPECIAL STAGE		7		AVERAGE	TIME ALLOWED:
Kotsiatis		13.64 km		50.96 km/h	60 min
DISTANCE		DIRECTION	INFORMATION	DISTANCE REGRESS.	
TOTAL	PARTIAL				
49.81	0.35		Take the 2nd exit	1.15	
50.34	0.53		Take the 4th exit	0.62	
50.69	0.35			0.27	
50.90	0.21			0.06	
50.96	0.06		 TC 7A REGROUPING IN TECHNICAL ZONE IN <div style="border: 1px solid black; padding: 2px; display: inline-block;"> N34 55.484 E33 36.043 </div>	0.00	

TC 7A REGROUPING IN/ TECH. ZONE IN			LEG:	2
TC 7B REGROUPING OUT / SERVICE IN			SECTION:	4
			TIME ALLOWED:	max 15 min
DISTANCE		DIRECTION	INFORMATION	DISTANCE REGRESS.
TOTAL	PARTIAL			
		 	 TC 7A REGROUPING IN <div style="border: 1px solid black; padding: 2px; width: fit-content; margin: 10px auto;"> N34 55.484 E33 36.043 </div>	
		 	 TC 7B REGROUPING OUT & SERVICE IN <div style="border: 1px solid black; padding: 2px; width: fit-content; margin: 10px auto;"> N34 55.498 E33 36.054 </div>	

TC 7B REGROUPING OUT / SERVICE IN				LEG:	2
TC 7C SERVICE OUT				SECTION:	5
				TIME ALLOWED SERVICE:	30 min
DISTANCE		DIRECTION	INFORMATION	DISTANCE REGRESS.	
TOTAL	PARTIAL				
		 	 TC 7B REGROUPING OUT & SERVICE IN <div style="border: 1px solid black; padding: 2px; width: fit-content; margin: 5px auto;"> N34 55.498 E33 36.054 </div>		
		 	 TC 7C SERVICE OUT <div style="border: 1px solid black; padding: 2px; width: fit-content; margin: 5px auto;"> N34 55.475 E33 36.053 </div>		

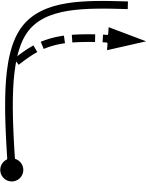
TC7C SERVICE OUT		DISTANCE:		LEG: 2	
TC8 KOTSIATIS		31.56 km		SECTION: 5	
		AVERAGE		TIME ALLOWED:	
		37.87 km/h		50 min	
DISTANCE		DIRECTION	INFORMATION	DISTANCE REGRESS.	
TOTAL	PARTIAL				
0.00	0.00	<div style="text-align: center;">  </div>	 <p>TC 7C SERVICE OUT</p> <div style="border: 1px solid black; padding: 2px; width: fit-content; margin: 5px auto;"> N34 55.004 E33 38.288 </div>	31.56	
0.07	0.07	<div style="text-align: center;">  </div>	  	31.49	
0.33	0.26	<div style="text-align: center;">  </div>	MALL	31.23	
0.65	0.32	<div style="text-align: center;">  </div>	Take the 1st exit	30.91	
1.50	0.85	<div style="text-align: center;">  </div>		30.06	
2.23	0.73	<div style="text-align: center;">  </div>	Take the 2nd exit	29.33	

TC7C SERVICE OUT		DISTANCE:		LEG: 2	
TC8 KOTSIATIS		31.56 km		SECTION: 5	
		AVERAGE		TIME ALLOWED:	
		37.87 km/h		50 min	
DISTANCE		DIRECTION	INFORMATION	DISTANCE REGRESS.	
TOTAL	PARTIAL				
3.15	0.92			28.41	
4.56	1.41		<p>Take the 2nd exit Join motorway (Rizoelia)</p>	27.00	
9.90	5.34			21.66	
23.77	13.87		<p>JOIN MOTORWAY LIMASSOL - NICOSIA</p> 	7.79	
25.85	2.08	 		5.71	
25.94	0.09			5.62	

TC7C SERVICE OUT		DISTANCE:		LEG: 2	
TC8 KOTSIATIS		31.56 km		SECTION: 5	
		AVERAGE 37.87 km/h		TIME ALLOWED: 50 min	
DISTANCE		DIRECTION	INFORMATION	DISTANCE REGRESS.	
TOTAL	PARTIAL				
28.76	2.82	<div style="display: flex; justify-content: space-around; align-items: center;"> <div style="text-align: center;">  50 KOTSIATHS </div> <div style="text-align: center;">  50 KOTSIATHS </div> </div> 	 50 KOTSIATHS	2.80	
		13			
29.49	0.73	 		2.07	
		14			
29.82	0.33			1.74	
		15			
31.56	1.74	 	<p style="text-align: center;">TC 8 KOTSIATIS</p>  <div style="border: 1px solid black; padding: 5px; width: fit-content; margin-left: auto;"> N34 59.860 E33 20.863 </div>	0.00	
		16			

TC 8 KOTSIATIS	DISTANCE:	LEG:	2
TC 8A Tech. Zone IN	50.96 km	SECTION:	5
SPECIAL STAGE	7	AVERAGE	TIME ALLOWED:
Kotsiatis	13.64 km	50.96 km/h	60 min

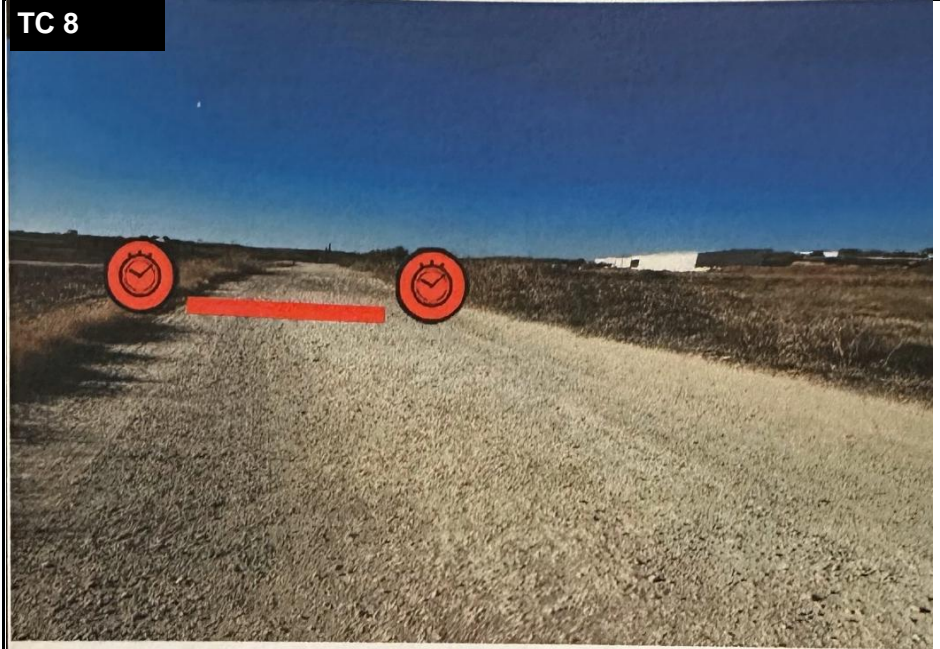

TC 8 KOTSIATIS	DISTANCE:	LEG:	2
TC 8A Tech. Zone IN	50.96 km	SECTION:	5
SPECIAL STAGE	7	AVERAGE	TIME ALLOWED:
Kotsiatis	13.64 km	50.96 km/h	60 min

FINISH SS8





STOP SS8



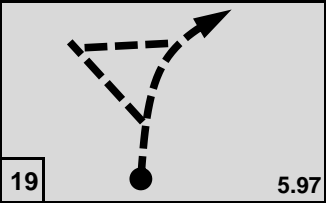
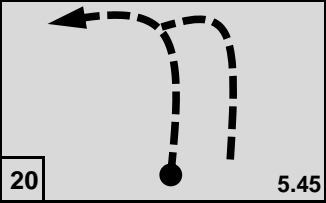
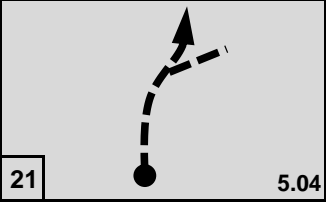
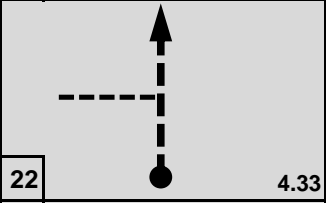
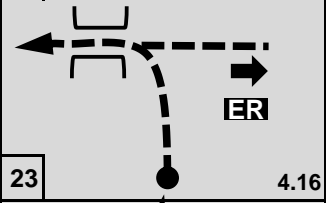

TC 8 KOTSIATIS		DISTANCE:		LEG: 2	
TC 8A Tech. Zone IN		50.96 km		SECTION: 5	
SPECIAL STAGE		7		AVERAGE	
Kotsiatis		13.64 km		TIME ALLOWED: 60 min	
DISTANCE		DIRECTION		INFORMATION	
TOTAL	PARTIAL			DISTANCE REGRESS.	
0.00	0.00			<p>START SS8 KOTSIATIS</p> <div style="border: 1px solid black; padding: 2px; display: inline-block;"> N34 59.925 E33 20.869 </div>	
		1	13.64		50.96
0.27	0.27				
		2	13.37		50.69
0.47	0.20				
		3	13.17		50.49
0.92	0.45				
		4	12.72		50.04
1.70	0.78				
		5	11.94		49.26
2.35	0.65				
		6	11.29		48.61

TC 8 KOTSIATIS		DISTANCE:		LEG:	2
TC 8A Tech. Zone IN		50.96 km		SECTION:	5
SPECIAL STAGE		7		AVERAGE	TIME ALLOWED:
Kotsiatis		13.64 km		50.96 km/h	60 min
DISTANCE		DIRECTION	INFORMATION	DISTANCE REGRESS.	
TOTAL	PARTIAL				
2.85	0.50			48.11	
3.04	0.19			47.92	
4.27	1.23		ER Evacuation Road <div style="border: 1px solid black; padding: 2px; display: inline-block;"> N34 58.190 E33 20.335 </div>	46.69	
5.27	1.00			45.69	
5.57	0.30			45.39	
5.82	0.25			45.14	

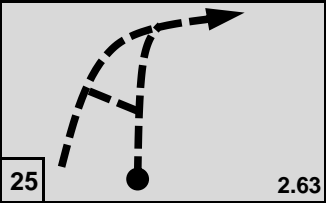
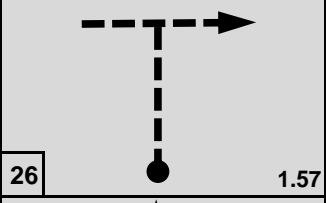
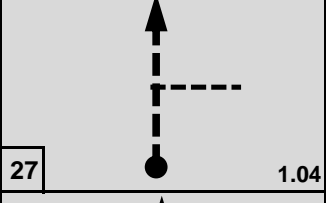
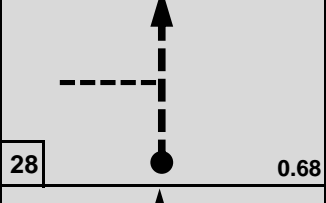
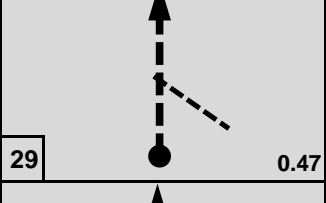

TC 8 KOTSIATIS		DISTANCE:		LEG: 2	
TC 8A Tech. Zone IN		50.96 km		SECTION: 5	
SPECIAL STAGE		7		AVERAGE	
Kotsiatis		13.64 km		TIME ALLOWED: 60 min	
DISTANCE		DIRECTION		INFORMATION	
TOTAL	PARTIAL			DISTANCE REGRESS.	
5.92	0.10			45.04	
6.15	0.23			44.81	
6.45	0.30			44.51	
6.75	0.30			44.21	
7.17	0.42			43.79	
7.23	0.06				
				<div style="border: 1px solid black; padding: 2px; display: inline-block;"> N34 59.719 E33 19.814 </div>	



TC 8 KOTSIATIS		DISTANCE:		LEG: 2	
TC 8A Tech. Zone IN		50.96 km		SECTION: 5	
SPECIAL STAGE		7		AVERAGE	
Kotsiatis		13.64 km		50.96 km/h	
				TIME ALLOWED: 60 min	
DISTANCE		DIRECTION		INFORMATION	
TOTAL	PARTIAL			DISTANCE REGRESS.	
7.67	0.44	19			43.29
8.19	0.52	20			42.77
8.60	0.41	21			42.36
9.31	0.71	22			41.65
9.48	0.17	23			41.48
9.60	0.12	24			41.36



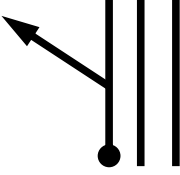

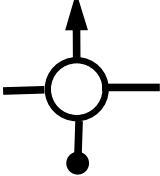
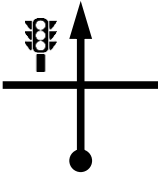
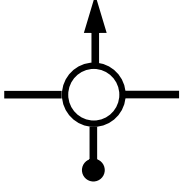
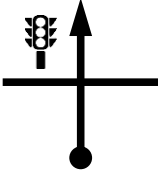
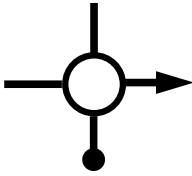

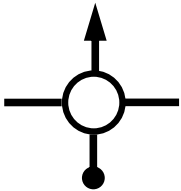
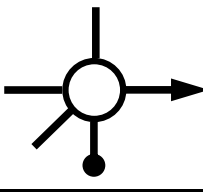
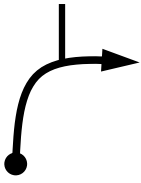
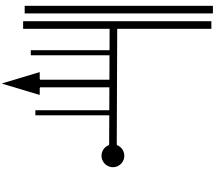
TC 8 KOTSIATIS		DISTANCE:		LEG:	2
TC 8A Tech. Zone IN		50.96 km		SECTION:	5
SPECIAL STAGE		7		AVERAGE	TIME ALLOWED:
Kotsiatis		13.64 km		50.96 km/h	60 min
DISTANCE		DIRECTION	INFORMATION	DISTANCE REGRESS.	
TOTAL	PARTIAL				
11.01	1.41	25		39.95	
12.07	1.06	26		38.89	
12.60	0.53	27		38.36	
12.96	0.36	28		38.00	
13.17	0.21	29		37.79	
13.36	0.19	30		37.60	







TC 8 KOTSIATIS		DISTANCE:		LEG: 2	
TC 8A Tech. Zone IN		50.96 km		SECTION: 5	
SPECIAL STAGE		7		AVERAGE	
Kotsiatis		13.64 km		TIME ALLOWED: 60 min	
DISTANCE		DIRECTION		INFORMATION	
TOTAL	PARTIAL			DISTANCE REGRESS.	
13.64	0.28				
13.91	0.27				
14.12	0.21			<p>TARMAC</p>	
16.45	2.33			<p>34.51</p>	
16.53	0.08			<p>34.43</p>	
16.61	0.08				





TC 8 KOTSIATIS		DISTANCE:		LEG: 2	
TC 8A Tech. Zone IN		50.96 km		SECTION: 5	
SPECIAL STAGE		7		AVERAGE	
Kotsiatis		13.64 km		50.96 km/h	
DISTANCE		DIRECTION		INFORMATION	
TOTAL	PARTIAL			DISTANCE REGRESS.	
18.89	2.28	37			32.07
19.37	0.48	38			31.59
20.07	0.70	39			30.89
22.63	2.56	40			28.33
23.15	0.52	41			27.81
23.27	0.12	42			27.69

TC 8		KOTSIATIS		DISTANCE:	LEG:	2
TC 8A		Tech. Zone IN		50.96 km	SECTION:	5
SPECIAL STAGE				7	AVERAGE	TIME ALLOWED:
Kotsiatis				13.64 km	50.96 km/h	60 min
DISTANCE		DIRECTION	INFORMATION	DISTANCE REGRESS.		
TOTAL	PARTIAL					
25.59	2.32		 <p>JOIN MOTORWAY TOWARDS LARNACA</p>	25.37		
45.59	20.00		<p>Take the 2ND exit RIZOELIA</p>	5.37		
46.91	1.32			4.05		
47.78	0.87		<p>Take the 2nd exit</p>	3.18		
48.58	0.80			2.38		
49.46	0.88		<p>Take the 3rd exit</p>	1.50		



TC 8 KOTSIATIS		DISTANCE:		LEG:	2
TC 8A Tech. Zone IN		50.96 km		SECTION:	5
SPECIAL STAGE			7	AVERAGE	TIME ALLOWED:
Kotsiatis			13.64 km	50.96 km/h	60 min
DISTANCE		DIRECTION	INFORMATION	DISTANCE REGRESS.	
TOTAL	PARTIAL				
49.81	0.35	<div style="border: 1px solid black; padding: 2px; width: fit-content; margin: 0 auto;">49</div> 	Take the 2nd exit	1.15	
50.34	0.53	<div style="border: 1px solid black; padding: 2px; width: fit-content; margin: 0 auto;">50</div> 	Take the 4th exit	0.62	
50.69	0.35	<div style="border: 1px solid black; padding: 2px; width: fit-content; margin: 0 auto;">51</div> 		0.27	
50.90	0.21	<div style="border: 1px solid black; padding: 2px; width: fit-content; margin: 0 auto;">52</div> 		0.06	
50.96	0.06	<div style="border: 1px solid black; padding: 2px; width: fit-content; margin: 0 auto;">53</div> 	 <p>TC 8A TECHNICAL ZONE IN</p> <div style="border: 1px solid black; padding: 2px; width: fit-content; margin: 0 auto;"> N34 55.484 E33 36.043 </div>	0.00	

TC 8A TECH ZONE IN			LEG:	2
TC 8B TECH ZONE OUT-SERVICE IN			SECTION:	5
			TIME ALLOWED SERVICE:	3 min
DISTANCE		DIRECTION	INFORMATION	DISTANCE REGRESS.
TOTAL	PARTIAL			
		  <div style="border: 1px solid black; display: inline-block; padding: 2px;">1</div>	 TC 8A TECH ZONE IN <div style="border: 1px solid black; padding: 2px; width: fit-content; margin: auto;"> N34 55.498 E33 36.054 </div>	
		  <div style="border: 1px solid black; display: inline-block; padding: 2px;">2</div>	 TC 8B TECH ZONE OUT SERVICE IN <div style="border: 1px solid black; padding: 2px; width: fit-content; margin: auto;"> N34 55.475 E33 36.053 </div>	

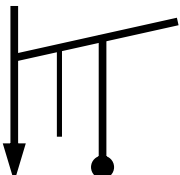
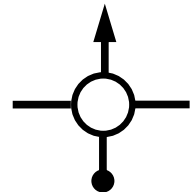
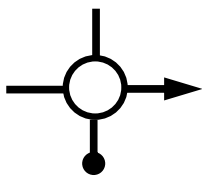
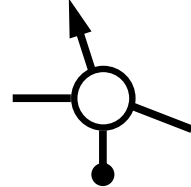
TC 8B SERVICE IN			LEG:	2
TC 8C SERVICE OUT			SECTION:	5
			TIME ALLOWED SERVICE:	15 min
DISTANCE		DIRECTION	INFORMATION	DISTANCE REGRESS.
TOTAL	PARTIAL			
		 	 TC 8B SERVICE IN <div style="border: 1px solid black; padding: 2px; width: fit-content; margin: 0 auto;"> N34 55.498 E33 36.054 </div>	
	1	 	 TC 8C SERVICE OUT <div style="border: 1px solid black; padding: 2px; width: fit-content; margin: 0 auto;"> N34 55.475 E33 36.053 </div>	

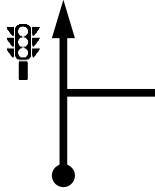
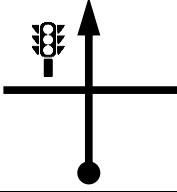
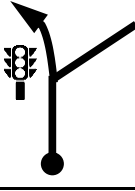
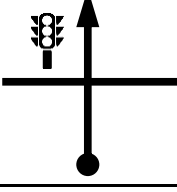
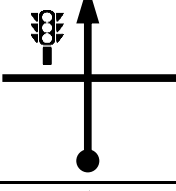
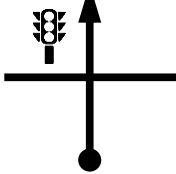
TC 8C SERVICE OUT		DISTANCE:	LEG:	2
TC 8D HOLDING CONTROL - FINISH		4.44 km	SECTION:	5
		AVERAGE	TIME ALLOWED SERVICE:	
		8.88 km/h	30 min	
DISTANCE		DIRECTION	INFORMATION	DISTANCE REGRESS.
TOTAL	PARTIAL			
0.00	0.00	1 	 <p>TC 8C SERVICE OUT</p> <div style="border: 1px solid black; padding: 2px; width: fit-content;"> N34 55.475 E33 36.053 </div>	4.44
0.04	0.04	2 	 <p>REFUELING</p> 	4.40
0.07	0.03	3 		4.37
0.38	0.31	4 	Take the 2nd exit	4.06
0.66	0.28	5 	Take the 3rd exit	3.78
1.40	0.74	6 	Take the 2nd exit	3.04

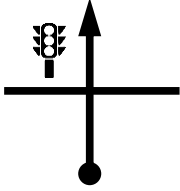
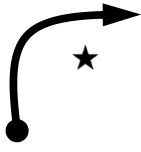
TC 8C SERVICE OUT		DIRECTION		INFORMATION	DISTANCE REGRESS.
TOTAL	PARTIAL				
2.16	0.76	7			2.28
2.58	0.42	8			1.86
3.10	0.52	9			1.34
3.34	0.24	10			1.10
3.72	0.38	11			0.72
3.91	0.19	12			0.53

TC 8C SERVICE OUT		DISTANCE:		LEG:	2
TC 8D HOLDING CONTROL - FINISH		4.44 km		SECTION:	5
		AVERAGE		TIME ALLOWED SERVICE:	
		8.88 km/h		30 min	
DISTANCE		DIRECTION	INFORMATION	DISTANCE REGRESS.	
TOTAL	PARTIAL				
4.18	0.27		Keep right lane!	0.26	
				13	
4.44	0.26		 TC 8D HOLDING CONTROL	0.00	
				14	<div style="border: 1px solid black; padding: 2px;"> N34 54.993 E33 38.281 </div>
FOLLOW MARSHALS' INSTRUCTIONS					
ΑΚΟΛΟΥΘΗΣΤΕ ΤΙΣ ΟΔΗΓΙΕΣ ΤΩΝ ΚΡΙΤΩΝ					
ΣΥΓΧΑΡΗΤΗΡΙΑ!!!					
CONGRATULATIONS!!!					